



T PROFILE

CLASSIC LINE

FOR MODULAR CEILING

TECHNICAL SPECIFICATIONS

Structure material:	Galvanized steel DX51D+Z100 MAC
Coating material:	Pre-painted steel DX51D+Z100 MAC
Connection between profiles:	Bearing: machined hook Secondary: machined hook classic line
Colour of coating:	Pre-painted White DONN-WHITE Silver / Black Mirror aluminium
Weight of structure:	ca. 1 Kg/m ²
Medium load capacity:	52,3 N
Fire reaction:	Class A1
Organic coating:	25µm polyester paint
Breaking load:	281 N/mm ²
Durability:	Class B
Flexion class:	1 (ONE)
Packaging:	Cardboard box with plastic strapping

GENERAL DESCRIPTION

T-profile with derived hook type "Classic line" suitable for internal use in buildings. It is particularly suitable for the construction of modular ceilings with standard dimensions 600x600 / 600x1200 / 300x1200. It consists of a 38mm high structure and a pre-painted coating (white or coloured) with an exposed dimension of 15mm. The elements that make up the system are: the PP3700 main runner, the IL1200 long cross-tee and the IC600 short cross-tee. The profile has a derived hook that with its shape ensures simple and quick assembly.

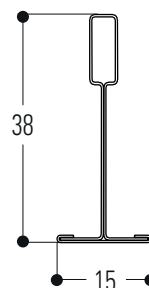

Section: PP 3700 mm
IL 1200 mm
IC 600 mm

STRUCTURE T "CLASSIC LINE"

Sez. 1

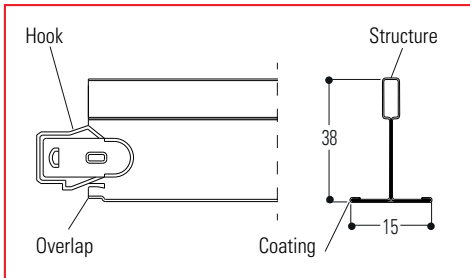

Sez. 2

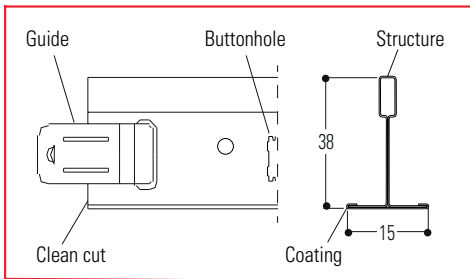

short middle profile: IC

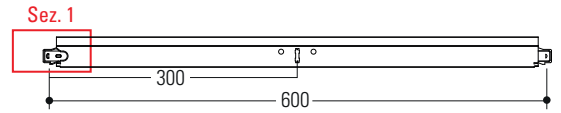

long middle profile: IL

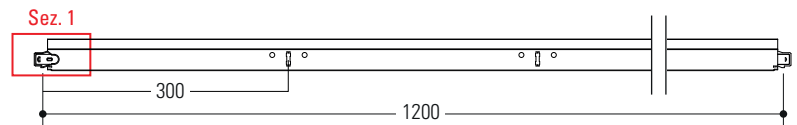

bearing profile: PP

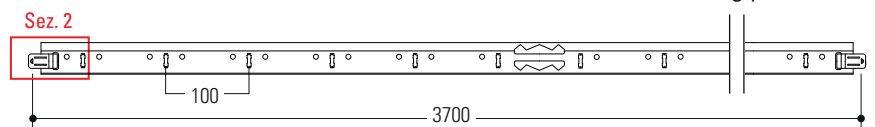

PROFILE TABLE

PROFILES	Pitch 100		Pitch 150		Pitch 156,25	
	Length (mm)	Pitch slots	Length (mm)	Pitch slots	Length (mm)	Pitch slots
Bearing profile: PPCL	3700*	100*	3750	150	3750	156,25
Long middle profile: ILCL	1000	-	1200	300	1250	312,5
	1200*	300*				
Short middle profile: ICCL	500	-	600	300	625	312,5
	600*	300*				

* The numbers marked in red refer to the measurements shown in the example above.

STRUCTURE INSTALLATION

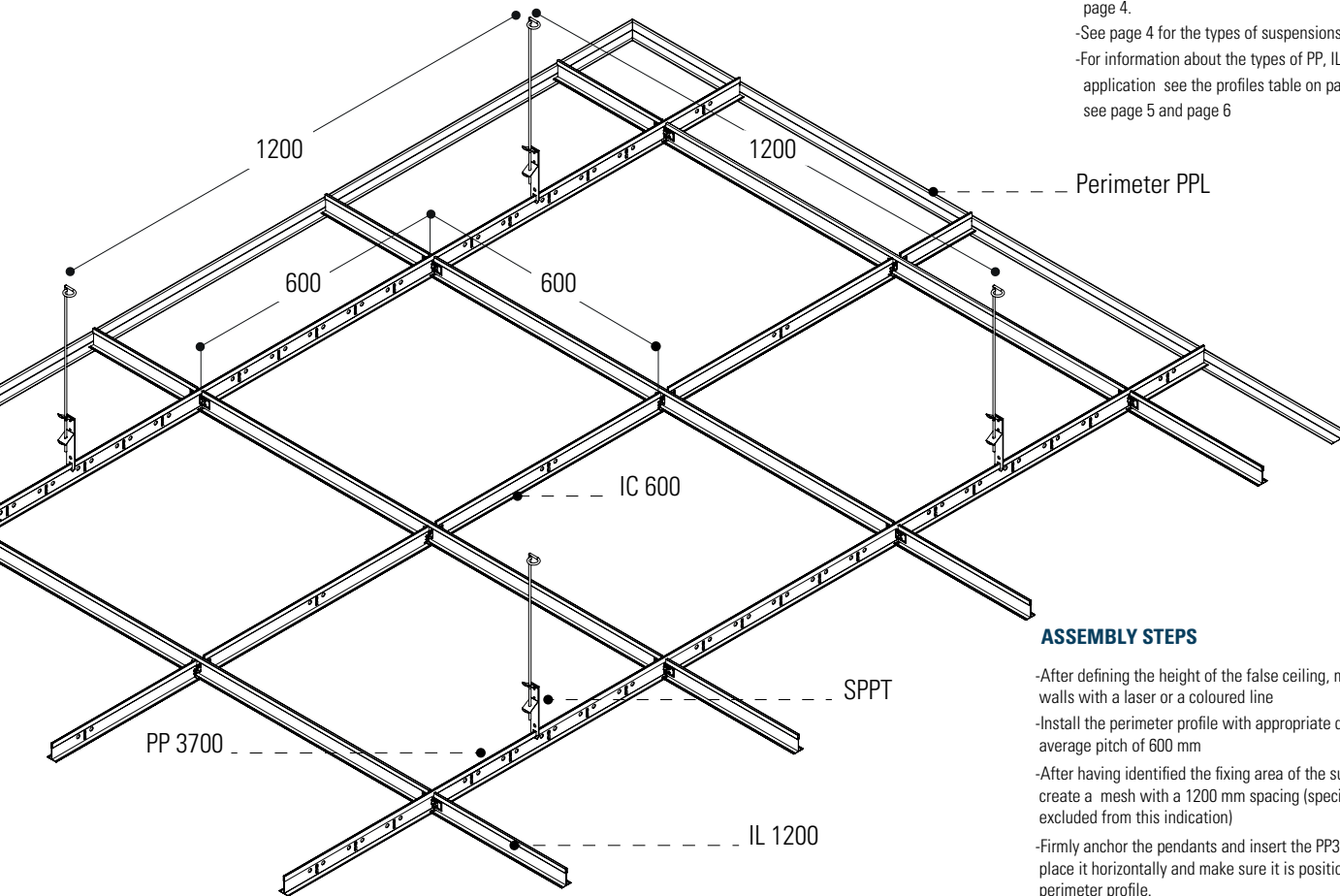

N.B. -For the pitches and lengths of the various profiles, see page 4.
 -See page 4 for the types of suspensions.
 -For information about the types of PP, IL, IC perimeter application see the profiles table on page 2 see page 5 and page 6

ASSEMBLY STEPS

- After defining the height of the false ceiling, mark it on the walls with a laser or a coloured line
- Install the perimeter profile with appropriate dowels with an average pitch of 600 mm
- After having identified the fixing area of the suspensions, create a mesh with a 1200 mm spacing (special cases are excluded from this indication)
- Firmly anchor the pendants and insert the PP3700 inside them, place it horizontally and make sure it is positioned on the perimeter profile.
- Install the bearing profiles with a pitch of 1200 mm, proceed with the assembly of the other profiles (IL, IC) and create the desired module.
- Insert the panels for the final closure of the false ceiling.

N.B. In the case of an anti-seismic system, please refer to the technical data sheet of the G-SEISMIC Kit or the leaflet that is included in each package.

DESCRIPTION AND MODULE CONFIGURATION

The visible substructure is formed by a "T" section profile, composed of a PB3700 bearing profile, a IL200 long middle profile and a IC600 middle profile. The PP3700 is suspended from the floor at a pitch of 1200mm by means of accessories, which have an assembly distance of 1200mm, while for the realisation of the grid it is sufficient to assemble the snap-on profile.

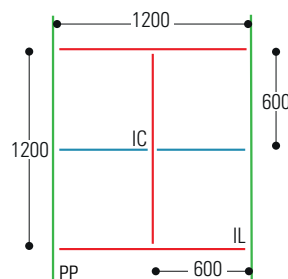

Module 600x600
Incidence: PP 3700 0.83 ml/mq
IL 1200 1.67 ml/mq
IC 600 0.83 ml/mq

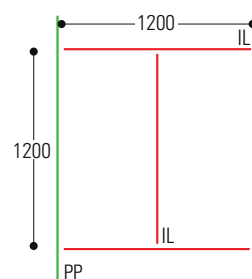

Module 600x1200
Incidence: PP 3700 0.83 ml/mq
IL 1200 1.67 ml/mq

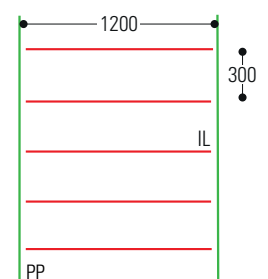

Module 300x1200
Incidence: PP 3700 0.83 ml/mq
IL 1200 3.33 ml/mq

APPLICATIONS, ACCESSORIES AND SUSPENSIONS

Accessory G-SEISMIC

In constructions where an anti-seismic performance is required, the system can be integrated with an anti-seismic kit type G-SEISMIC, applied on the bearing profile and on the perimeters.

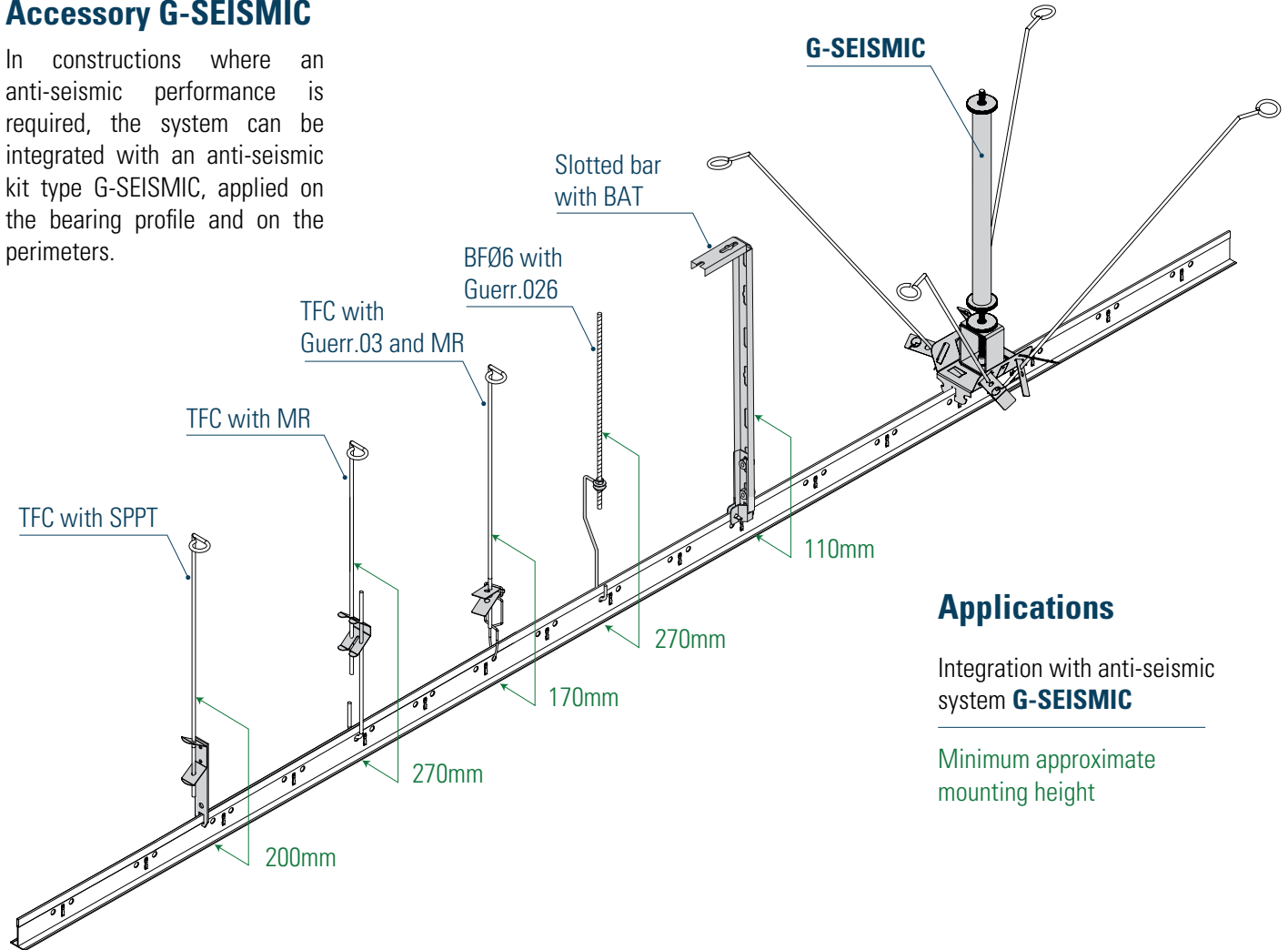

Applications

Integration with anti-seismic system **G-SEISMIC**

Minimum approximate mounting height

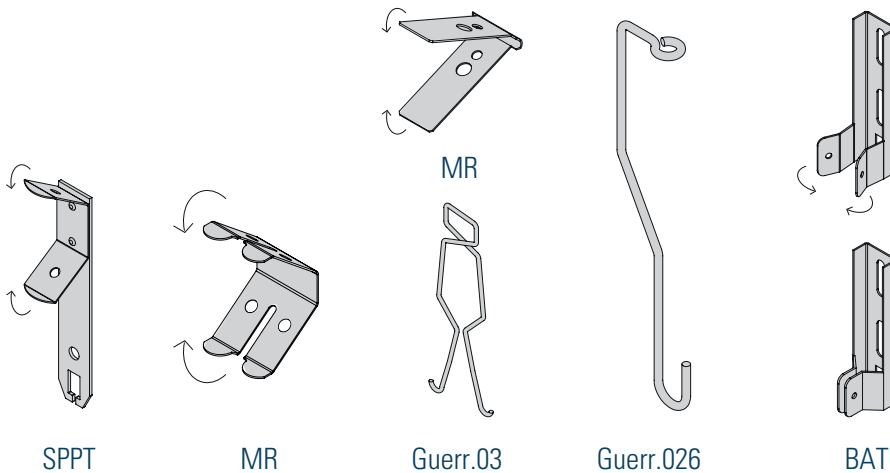

Description

The T-structure has the possibility of several types of suspensions, each of which has its own characteristics that make the suspension of the structure suitable, effective and safe for any type of ceiling. The assembly of the suspensions is simple and intuitive and guarantees practicality when setting up the structure.

PERIMETER PROFILES

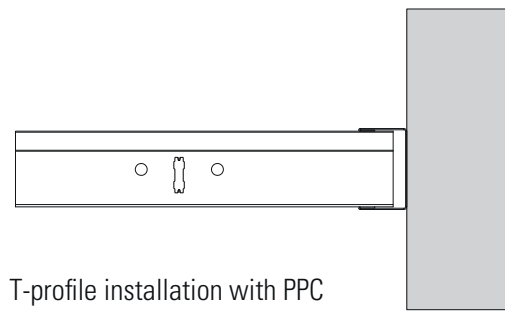
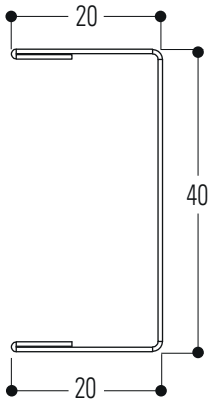

T-profile installation with PPC

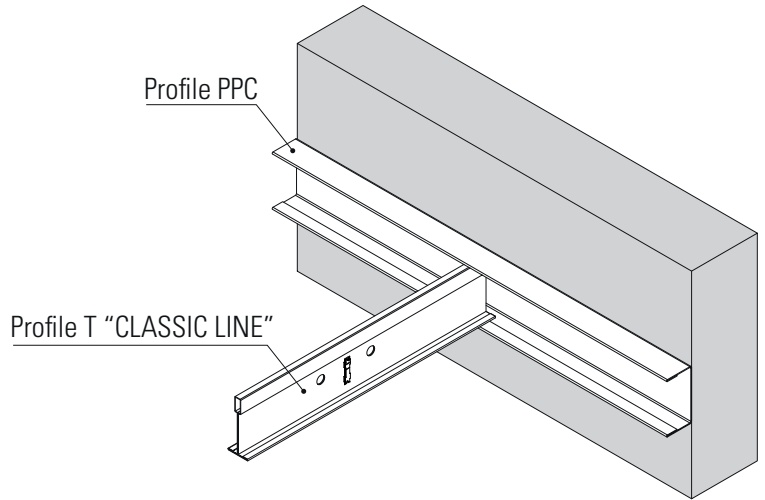

In addition to its function as a perimeter profile, the **PPC** profile has the characteristic of making a cut metal panel coplanar by using a C profile inside it, in order to favour its rigidity and blocking. The colour of the PPC profile can vary according to the T structure or the chosen panels that will be mounted on the false ceiling.

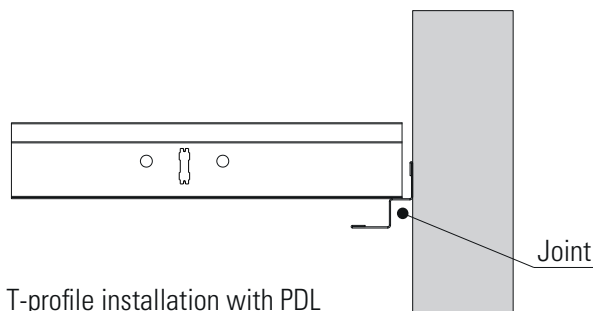
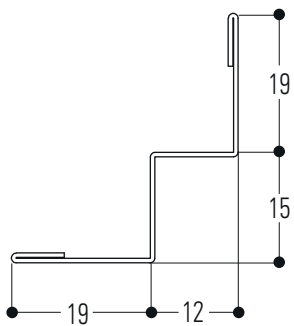

T-profile installation with PDL

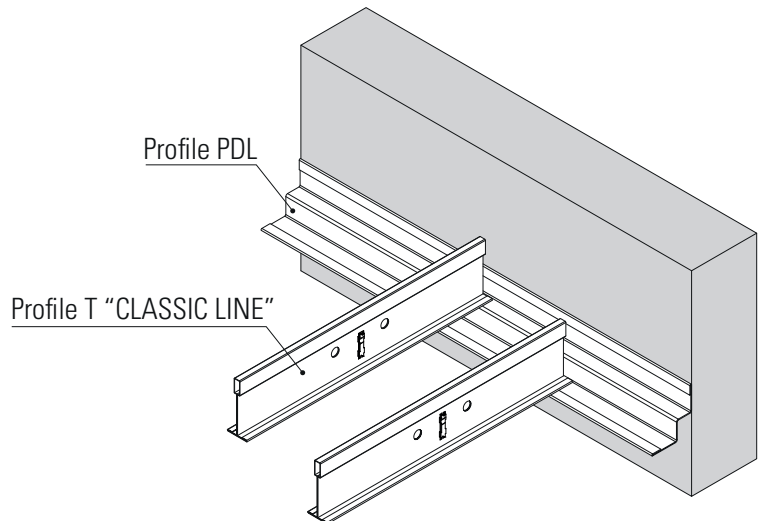

In addition to its function as a perimeter profile, the **PDL** profile has the characteristic of making shutters due to its stepped shape and thanks to this it is possible to place the T-profile on the upper or lower part of it. The colour of the PDL profile can differ depending on the T-profile or the chosen panels that will be mounted on the false ceiling.

PERIMETER PROFILES

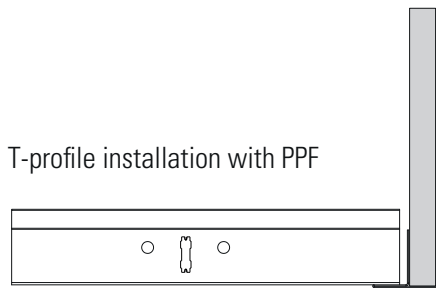
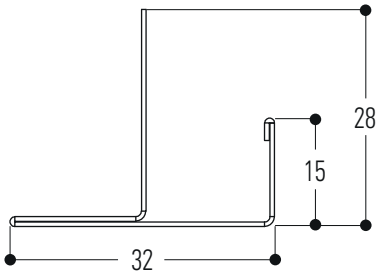

T-profile installation with PPF

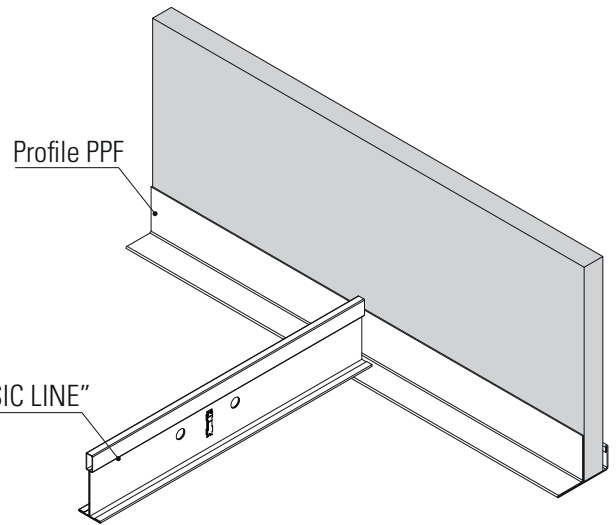

Profile T "CLASSIC LINE"

The **PPF** profile may vary depending on T-structure or chosen panels, but it also has the capacity to be used as a connection profile for height differences (e.g. soffits), in order to avoid additional grouting processes. It is possible to insert 13 to 15 mm plasterboard panels. The colour of the PPF profile may vary depending on the T-structure or the chosen panels that will be mounted on the false ceiling.

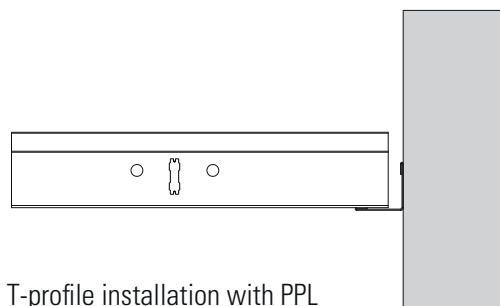
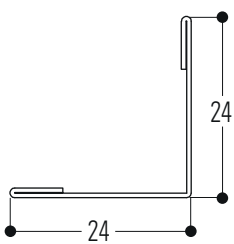

T-profile installation with PPL

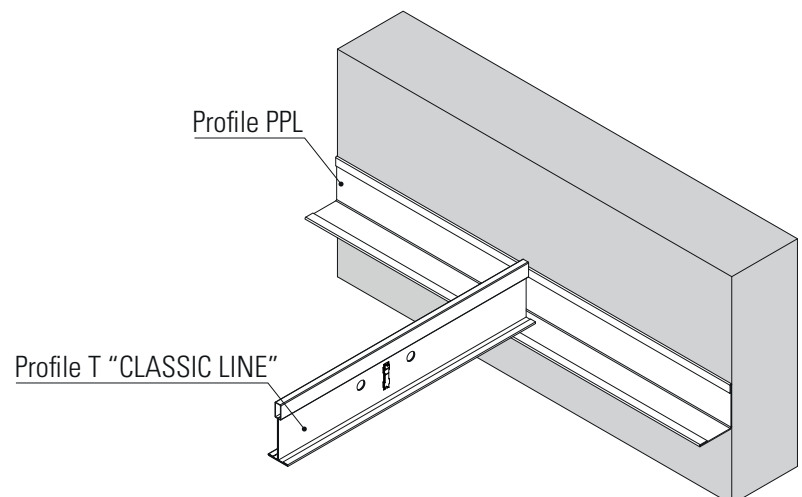

Profile T "CLASSIC LINE"

The **PPL** is a classic L perimeter profile suitable for panel application (see some possible applications on page 49). (See some possible applications on page 49.) The colour of the PPL profile can differ depending on the T-structure or the chosen panels that will be mounted on the ceiling.

POSSIBLE APPLICATIONS OF PANELS

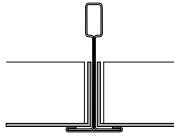

VERT VISIO

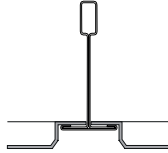

VERT SEMI VISIO

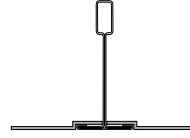

VERT FLAT

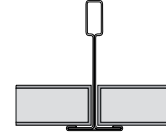

MICROFIBER
PANEL

N.B. The following representations are indicative and are suitable for application with the profiles indicated on pages 5 and 6 in order to view each single system, we recommend downloading the "integrated ceilings" catalogue from the vertebra.com website.

NORMATIVE REFERENCES

- Construction product according to Regulation (EU) 305/2011
- CE marking in accordance with EN 13964
- Sheet metal quality and coating grade in accordance with EN 10143 and EN 10346

CE MARKING

The products listed in this catalogue are intended for use inside buildings. Each product has a Declaration of Performance (DoP). Reaction to fire: class A1/Durability: class B (building components exposed to relative humidity varying up to 90% and temperatures varying up to 30°C but without corrosive pollutants, except for products in class C5-M).

PRODUCT STORAGE

The packages should be stored under cover in a relatively dry atmosphere and at a temperature as constant as possible, in order to avoid condensation which could reduce the passivation protection of the galvanised surface. In the case of outdoor storage (not recommended), use a cover that provides perfect protection of the material against the weather (rain, fog, snow), taking care to place the packages at a slight angle. This cover must in any case be such as to allow adequate ventilation (not bringing the two surfaces into direct contact) so that humidity does not accumulate and create condensation.

PACKAGING AND PALLET "CLASSIC LINE" T-PROFILE SHORT MIDDLE IC 600 - 15/38

BOXES

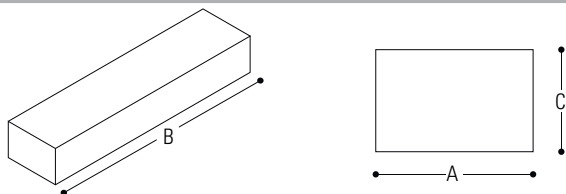

Profiles	Pcs	64
Quantity	M	45
Weight	Kg	13
Dimensions	Cm	15 65 10 a b c

PALLET

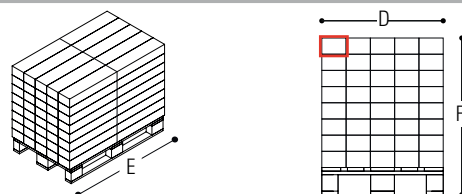

Boxes	Pcs	40
Total profiles	Pcs	3000
Quantity	M	1800
Weight	Kg	560
Dimensions	Cm	75 125 89 d e f

PACKAGING AND PALLET "CLASSIC LINE" T-PROFILE LONG MIDDLE IL 1200 - 15/38

BOXES

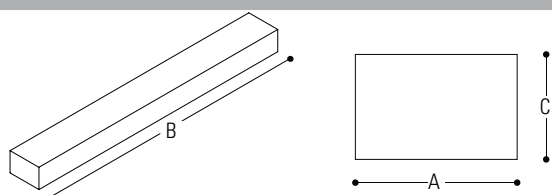

Profiles	Pcs	64
Quantity	M	76.8
Weight	Kg	26
Dimensions	Cm	15 125 10 a b c

PALLET

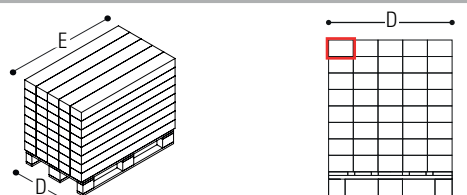

Boxes	Pcs	40
Total profiles	Pcs	2560
Quantity	M	3072
Weight	Kg	1050
Dimensions	Cm	75 125 89 d e f

PACKAGING AND PALLET "CLASSIC LINE" T-PROFILE BEARING PP 3700 - 15/38

BOXES

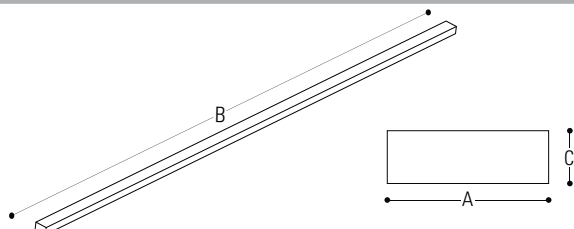

Profiles	Pcs	20
Quantity	M	74
Weight	Kg	25
Dimensions	Cm	100 375 45 a b c

PALLET

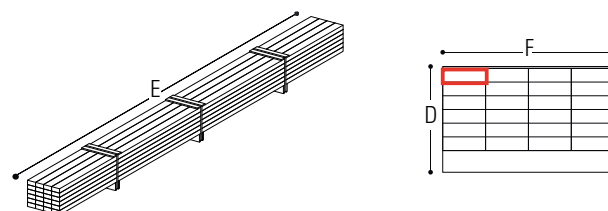

Boxes	Pcs	24
Total profiles	Pcs	480
Quantity	M	1776
Weight	Kg	600
Dimensions	Cm	40 375 41.5 d e f