

T PROFILE

FOR MODULAR CEILING

FRECCIA

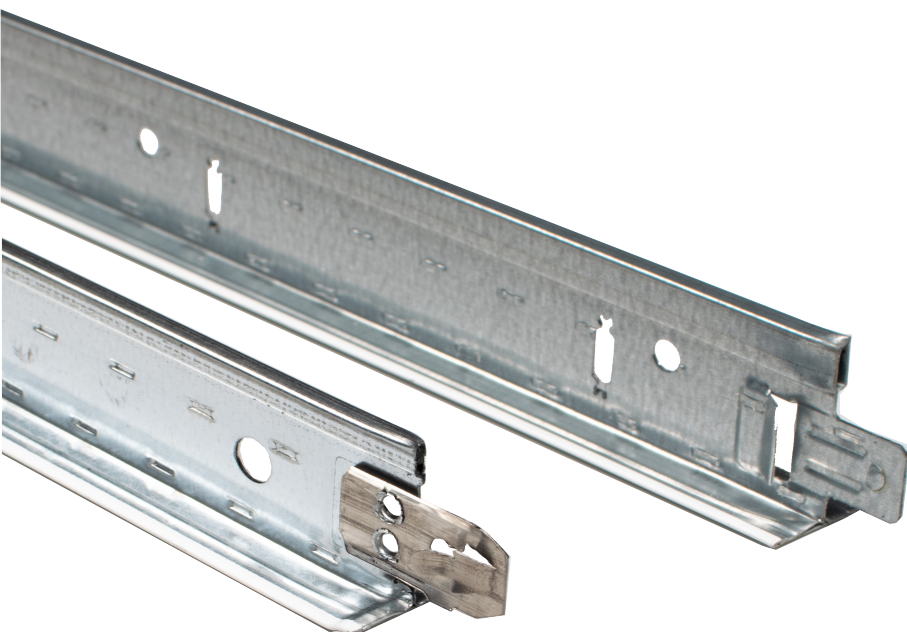

TECHNICAL SPECIFICATION

Structure material:	Galvanized steel DX51D+Z100 MAC
Coating material:	Pre-painted steel DX51D+Z100 MAC
Hook material:	Stainless steel
Connection between profiles:	Bearing profile: arrow pressed hook Secondary: clip hook
Colour of coating:	Pre-painted White DONN-WHITE Silver / Black Mirror aluminium
Weight of structure:	ca. 1 Kg/m ²
Medium load capacity:	52,3 N
Fire reaction:	Class A1
Organic coating:	25µm polyester paint
Breaking load:	281 N/mm ²
Durability:	Class B
Flexion class:	1 (ONE)
Packaging:	Cardboard box with plastic strapping

GENERAL DESCRIPTION

T-profile with "FRECCIA" type reported hook, suitable for indoor use in buildings. It is particularly suitable for the construction of modular false ceilings, with standard dimensions 600x600 / 600x1200 / 300x1200. It is composed of a 38 and 32 mm high structure and a pre-painted finish (white or coloured) which has an exposed dimension of 24 mm. The elements that compose the system are: the PP3700 bearing profile, the IL200 long middle profile and the IC600 short middle profile. The profile has an Freccia hook which is made of stainless steel and its shape guarantees simple and quick assembly. The slot, with high tensile strength, facilitates insertion or removal of the cross profile by simple finger pressure

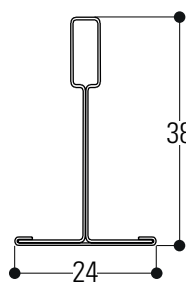

Section: PP 3700 mm

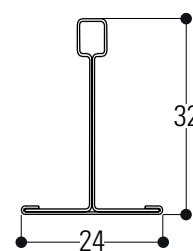

 Section: IL 1200 mm
IC 600 mm

STRUCTURE T "FRECCIA"

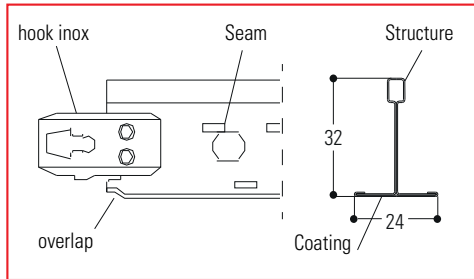
Sez. 1

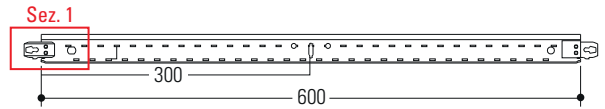

short middle profile: IC



long middle profile: IL

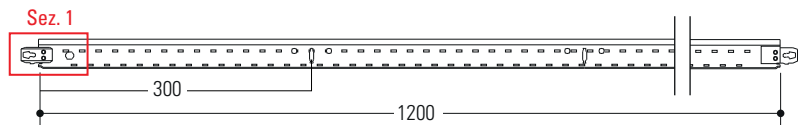

Sez. 2

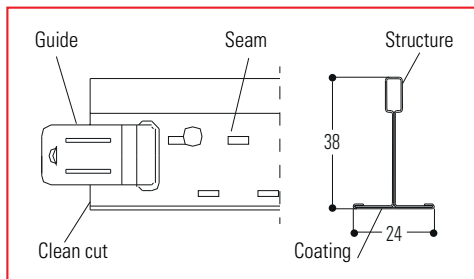

bearing profile: PP

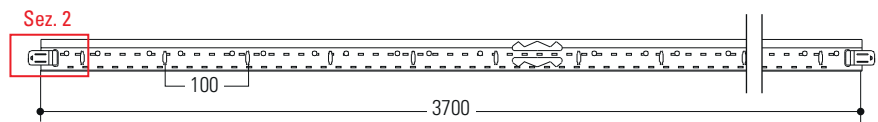

PROFILE TABLE

PROFILES	Pitch 100		Pitch 150		Pitch 156,25	
	Length (mm)	Pitch slots	Length (mm)	Pitch slots	Length (mm)	Pitch slots
Bearing profile: PPFR	3700*	100*	3750	150	3750	156,25
Long middle profile ILFR	800	-	900	450	1250	312,5
	900	450	1200	300		
	915	457,5	1500	-		
	1000	-	1800	-		
	1100	550				
	1200*	300*				
	1220	305				
	1300	-				
	1400	-				
	1500	-				
	1600	-				
1700	-					
1800	-					
Short middle profile: ICFR	400	-	450	-	625	312,5
	450	-	600	300		
	500	-				
	600*	300*				
	610	305				
	700	-				

* The numbers marked in red refer to the measurements shown in the example above.

STRUCTURE INSTALLATION

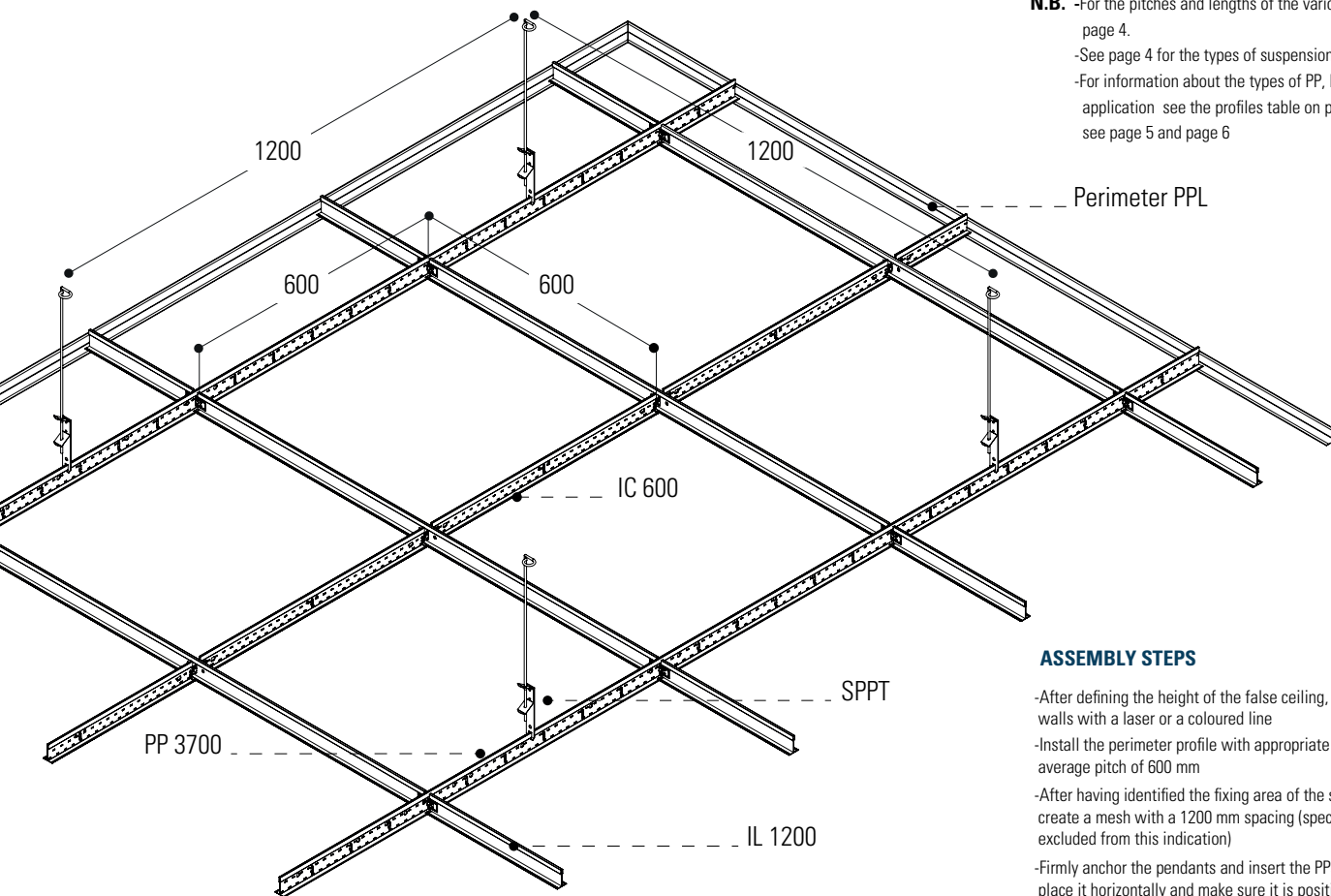

N.B. -For the pitches and lengths of the various profiles, see page 4.
 -See page 4 for the types of suspensions.
 -For information about the types of PP, IL, IC perimeter application see the profiles table on page 2 see page 5 and page 6

ASSEMBLY STEPS

- After defining the height of the false ceiling, mark it on the walls with a laser or a coloured line
- Install the perimeter profile with appropriate dowels with an average pitch of 600 mm
- After having identified the fixing area of the suspensions, create a mesh with a 1200 mm spacing (special cases are excluded from this indication)
- Firmly anchor the pendants and insert the PP3700 inside them, place it horizontally and make sure it is positioned on the perimeter profile.
- Install the bearing profiles with a pitch of 1200 mm, proceed with the assembly of the other profiles (IL, IC) and create the desired module.
- Insert the panels for the final closure of the false ceiling.

N.B. In the case of an anti-seismic system, please refer to the technical data sheet of the G-SEISMIC Kit or the leaflet that is included in each package.

DESCRIPTION AND MODULE CONFIGURATION

The visible substructure is formed by a "T" section profile, composed of a PP3700 bearing profile, a IL200 long middle profile and a IC600 middle profile. The PP3700 is suspended from the floor at a pitch of 1200mm by means of accessories, which have an assembly distance of 1200mm, while for the realisation of the grid it is sufficient to assemble the snap-on profile.

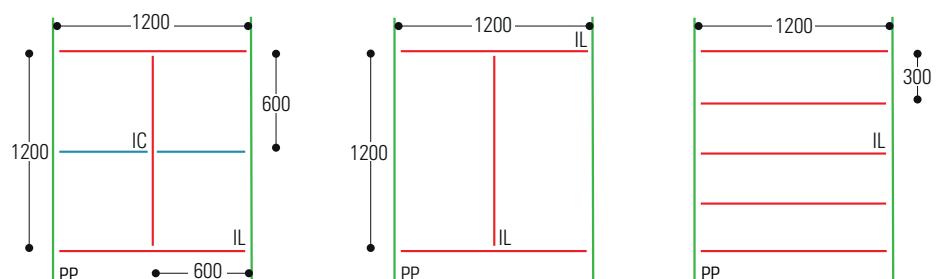

Module 600x600
Incidence: PP 3700 0.83 ml/mq
IL 1200 1.67 ml/mq
IC 600 0.83 ml/mq

Module 600x1200
Incidence: PP 3700 0.83 ml/mq
IL 1200 1.67 ml/mq

Module 300x1200
Incidence: PP 3700 0.83 ml/mq
IL 1200 3.33 ml/mq

APPLICATIONS, ACCESSORIES AND SUSPENSIONS

Accessory G-SEISMIC

In constructions where an anti-seismic performance is required, the system can be integrated with an anti-seismic kit type G-SEISMIC, applied on the bearing profile and on the perimeters.

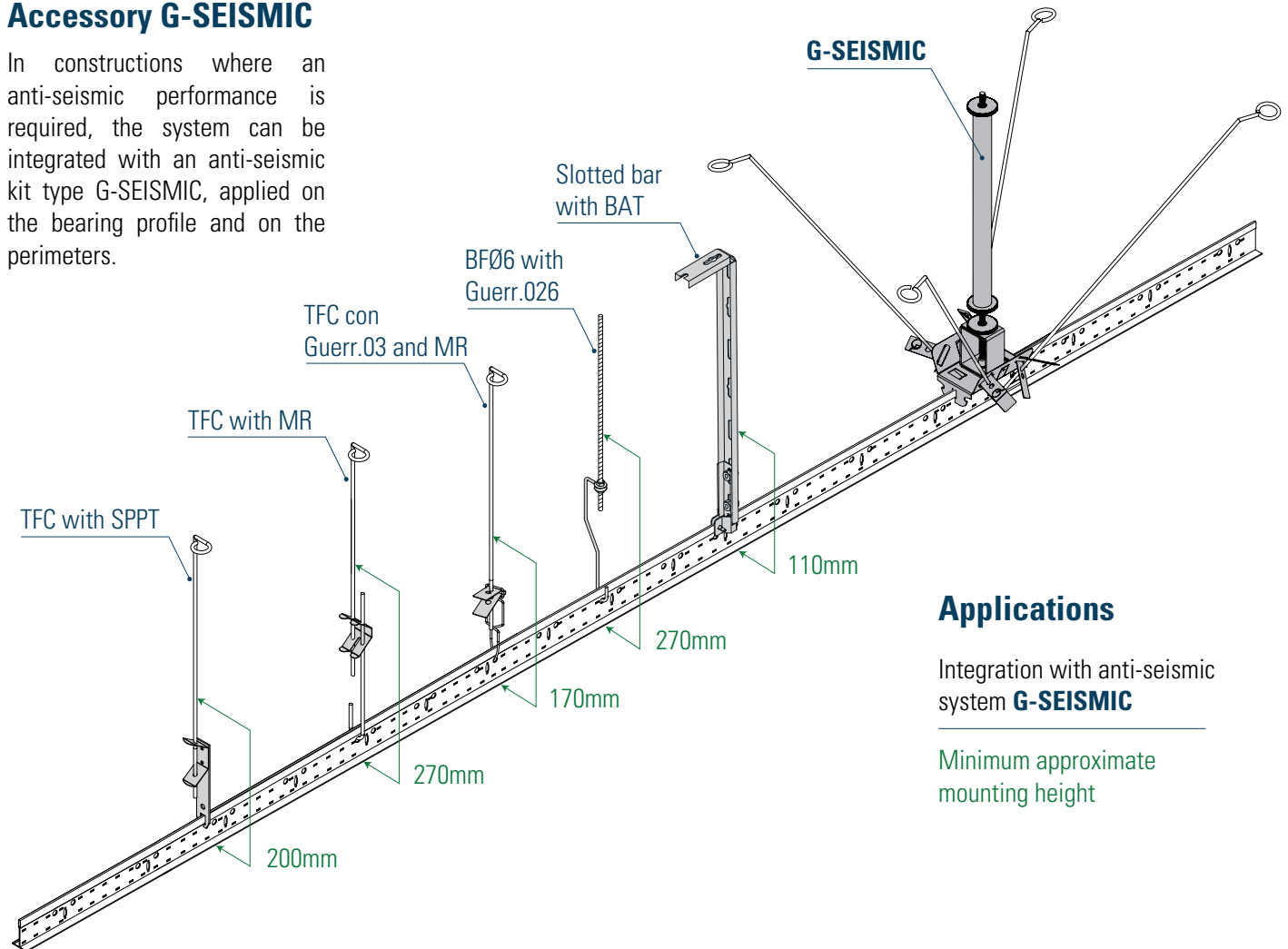

Applications

Integration with anti-seismic system **G-SEISMIC**

Minimum approximate mounting height

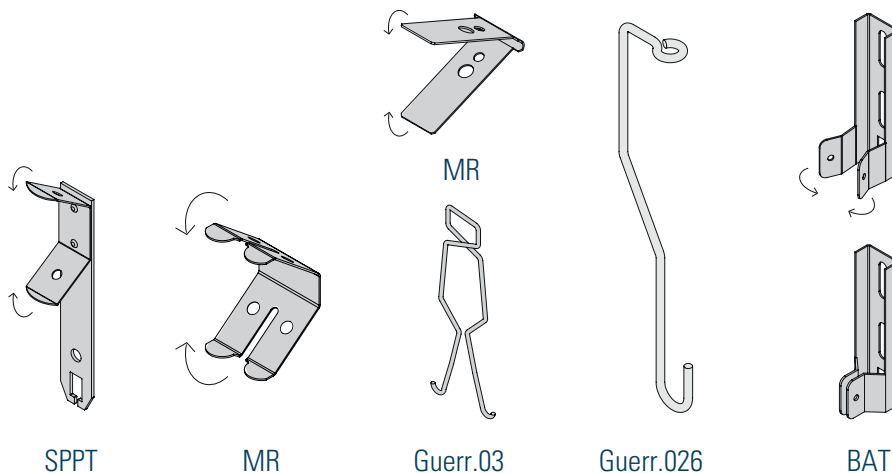

Description

The T-structure has the possibility of several types of suspensions, each of which has its own characteristics that make the suspension of the structure suitable, effective and safe for any type of ceiling. The assembly of the suspensions is simple and intuitive and guarantees practicality when setting up the structure.

PERIMETER PROFILES

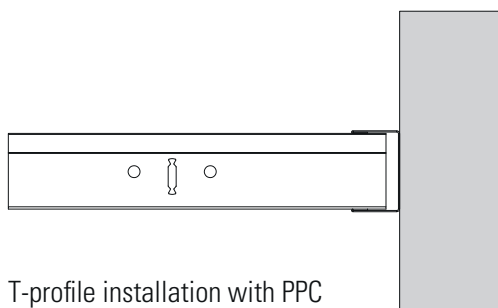
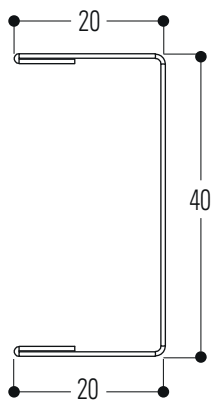

T-profile installation with PPC

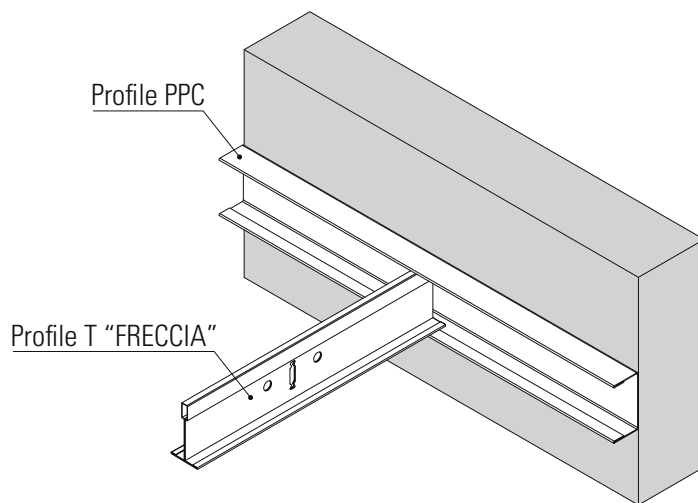

In addition to its function as a perimeter profile, the **PPC** profile has the characteristic of making a cut metal panel coplanar by using a C profile inside it, in order to favour its rigidity and blocking. The colour of the PPC profile can vary according to the T structure or the chosen panels that will be mounted on the false ceiling..

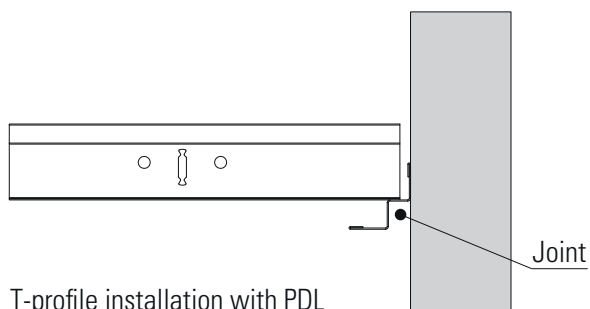
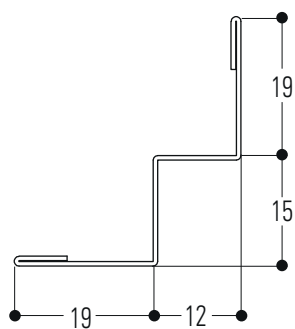

T-profile installation with PDL

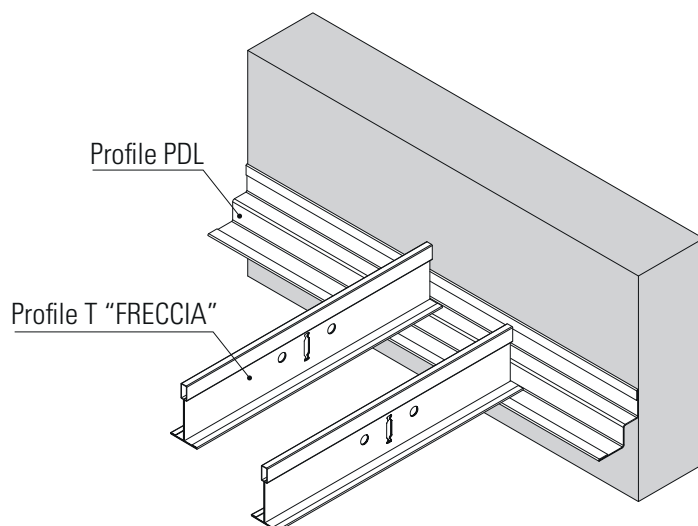

In addition to its function as a perimeter profile, the **PDL** profile has the characteristic of making shutters due to its stepped shape and thanks to this it is possible to place the T-profile on the upper or lower part of it. The colour of the PDL profile can differ depending on the T-profile or the chosen panels that will be mounted on the false ceiling.

PERIMETER PROFILES

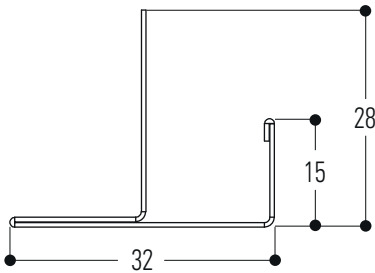

T-profile installation with PPF

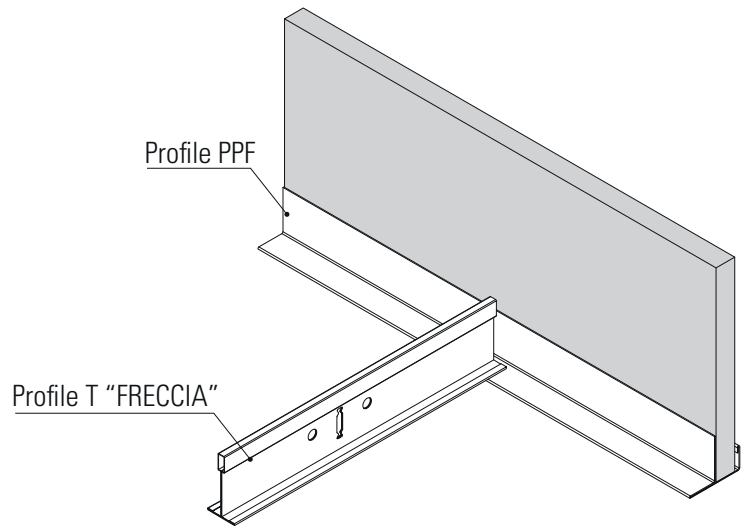
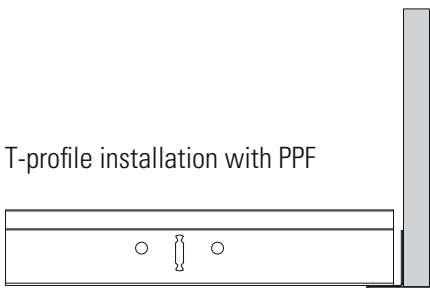

The **PPF** profile may vary depending on T-structure or chosen panels, but it also has the capacity to be used as a connection profile for height differences (e.g. soffits), in order to avoid additional grouting processes. It is possible to insert 13 to 15 mm plasterboard panels. The colour of the PPF profile may vary depending on the T-structure or the chosen panels that will be mounted on the false ceiling.

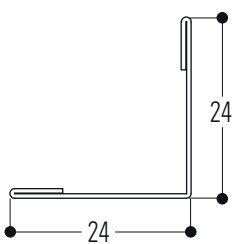

T-profile installation with PPL

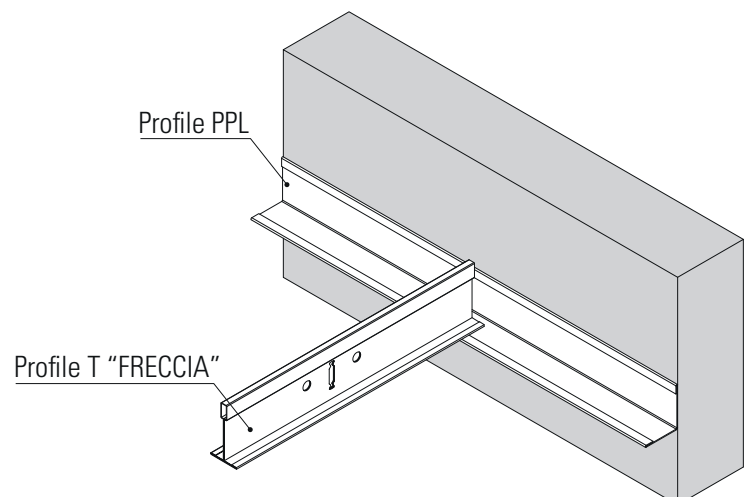
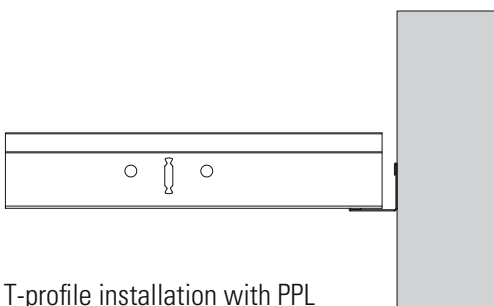

The **PPL** is a classic L perimeter profile suitable for panel application (see some possible applications on page 49). (See some possible applications on page 49.) The colour of the PPL profile can differ depending on the T-structure or the chosen panels that will be mounted on the ceiling.

POSSIBLE APPLICATIONS OF PANELS

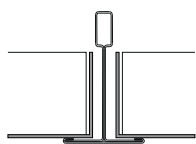

| VERT VISIO

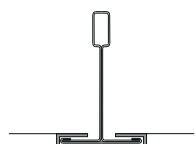

| VERT SEMI VISIO

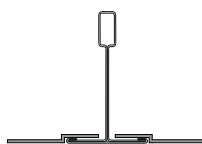

| VERT FLAT

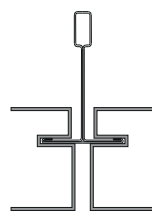

| VERT BOX

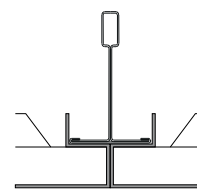

| VERT LAB

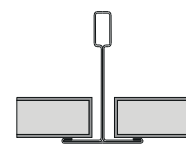
| MICROFIBER
PANEL

N.B. The following representations are indicative and are suitable for application with the profiles indicated on pages 5 and 6 in order to view each single system, we recommend downloading the "integrated ceilings" catalogue from the vertebra.com website.

NORMATIVE REFERENCES

- Construction product according to Regulation (EU) 305/2011
- CE marking in accordance with EN 13964
- Sheet metal quality and coating grade in accordance with EN 10143 and EN 10346

CE MARKING

The products listed in this catalogue are intended for use inside buildings. Each product has a Declaration of Performance (DoP). Reaction to fire: class A1/Durability: class B (building components exposed to relative humidity varying up to 90% and temperatures varying up to 30°C but without corrosive pollutants, except for products in class C5-M).

PRODUCT STORAGE

The packages should be stored under cover in a relatively dry atmosphere and at a temperature as constant as possible, in order to avoid condensation which could reduce the passivation protection of the galvanised surface. In the case of outdoor storage (not recommended), use a cover that provides perfect protection of the material against the weather (rain, fog, snow), taking care to place the packages at a slight angle. This cover must in any case be such as to allow adequate ventilation (not bringing the two surfaces into direct contact) so that humidity does not accumulate and create condensation.

PACKAGING AND PALLET "FREACCIA" T-PROFILE SHORT MIDDLE IC 600 - 24/32

BOXES

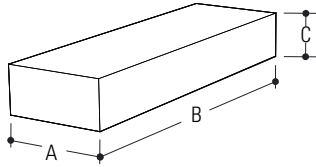

Profiles	Pcs	75
Quantity	M	45
Weight	Kg	14
Dimensions	Cm	19 65.5 12 a b c

PALLET

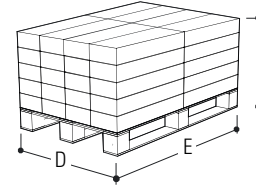

Boxes	Pcs	40
Total profiles	Pz	3000
Quantity	M	1800
Weight	Kg	560
Dimensions	Cm	80 125 75 d e f

PACKAGING AND PALLET "FRECCIA" T-PROFILE LONG MIDDLE IL 1200 - 24/32

BOXES

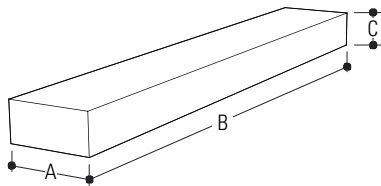

Profiles	Pcs	75
Quantity	Mt	90
Weight	Kg	27
Dimensions	Cm	19 125 12 a b c

PALLET

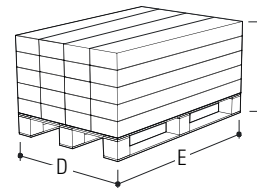

Boxes	Pcs	20
Total profiles	Pcs	1500
Quantity	M	1800
Weight	Kg	540
Dimensions	Cm	80 125 75 d e f

PACKAGING AND PALLET "FRECCIA" T- PROFILE BEARING PP 3700 - 24/38

BOXES

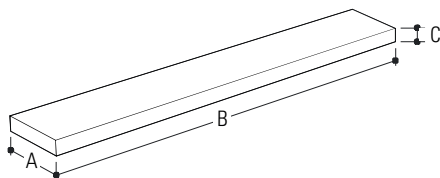

Profiles	Pcs	25
Quantity	M	92.5
Weight	Kg	32
Dimensions	Cm	19 375 6 a b c

PALLET

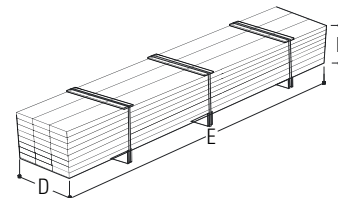

Boxes	Pcs	24
Total profiles	Pcs	600
Quantity	M	2220
Weight	Kg	780
Dimensions	Cm	60 375 55 d e f